









## QM-12 Thermal Actuator



### General Specifications

-  Power: 2.5 Watt
-  Voltage: 230VAC
-  Response Time: 270s
-  Force: 90-120 N
-  Total Movement: 4.00mm
-  Current: <550mA max. current <100ms
-  Working Temperature: -5 to 50 °C
-  CE complaint

### Dimensions

- max. D X H = 41.00mm X 60.00mm
- Cable Length: 750mm
- Cable Type: R 4.5 mm 2 core L N

### Installation

- Heating Collector
- Zone Valve

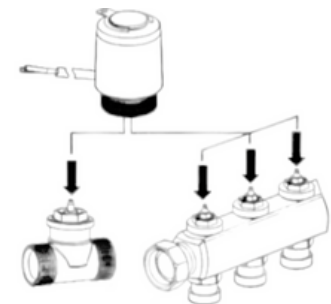

Vertical Installation IP44

Horizontal Installation IP 42









\*\*upside down installation is not allowed on this product

\*\*Dimensions in mm

# QM-12 Termal Aktüatör



## Genel Özellikler

-  Güç : 2.5 Watt
-  Voltaj: 230VAC
-  Tepki Süresi: 270s
-  Kuvvet: 90-120 N
-  Toplam Hareket: 4.00mm
-  Akım: <550mA maks. akım <100ms
-  Çalışma Sıcaklığı: -5 to 50 °C
-  CE uyumlu

## Boyutlar

- maks. Ç X Y = 41.00mm X 60.00mm
- Kablo Uzunluğu: 750mm
- Kablo Tipi: R 4.5 mm 2 core L N

## Montaj

- Isıtma Kollektörleri
- Zon Vanaları

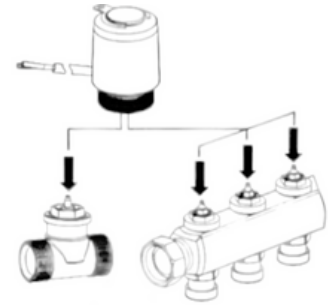
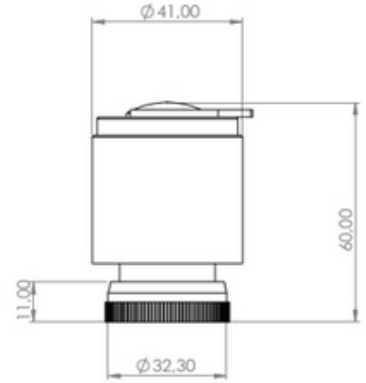

Dikey Montaj IP44  
Yatay Montaj IP 42  
\*\*ters montaj yapılmasına izin verilmez.

\*\*Dimensions in mm